



# thermoscreens®

C RANGE AIR CURTAINS

**INSTALLATION, OPERATION & MAINTENANCE INSTRUCTIONS**



**PLEASE READ THESE INSTRUCTIONS CAREFULLY BEFORE ATTEMPTING INSTALLATION**

Thermoscreens Ltd  
St. Mary's Road Nuneaton  
Warwickshire England  
CV11 5AU

Email: [sales@thermoscreens.com](mailto:sales@thermoscreens.com)  
Tel: +44 (0) 24 7638 4646  
Fax: +44 (0) 24 7638 8578  
[www.thermoscreens.com](http://www.thermoscreens.com)



# UN-PACKING YOUR C AIR-CURTAIN

The following items are supplied and packaged within the boxes.

## ■ C Air Curtain



Please note end caps are supplied loose and can be fitted during installation

## ■ Remote Control

Ecopower  
Electric & LPHW



Manual  
Ambient



## ■ Motorised Valve (Ecopower LPHW units only)



## ■ Wall Brackets & Fixing Bolts



(additional bracket and bolts supplied for C1500/C2000 models)

**Note** Optional filters are available on Water and Ambient models only and are packed separately.

If anything is missing or damaged please contact your place of purchase immediately.

### For your records

Date of Purchase.....  
Place of Purchase.....  
Serial Number.....

**For warranty purposes proof of purchase is necessary so please keep a copy of your invoice.**

(All documentation supplied with each unit should be stored and kept for future reference).

## INSTALLATION OF YOUR HORIZONTAL APPLICATION C AIR-CURTAIN

The C air curtain has been designed for surface mounting only inside of the building.

### Location

Ensure that the unit is mounted within its height specification of 1.8m minimum to 3.0m maximum (from floor level to the underside of the unit) and that it is situated as close to the door as possible with a 100mm air gap above the air curtain (see adjacent figure). In some cases it may not be possible to mount the air curtain as close to the door as possible as the air stream may strike the top edge of the doorway, a structural beam or a door opening device etc, therefore this will have to be taken into account when locating the unit.

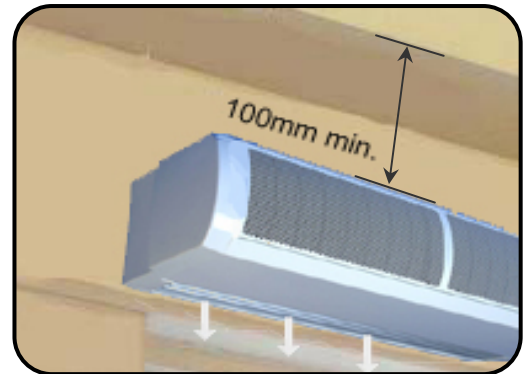

### Wall Fixing

Bolt the wall brackets to the rear face of the unit as shown in the adjacent figure (using the bolts supplied). Before fitting the unit to the wall obtain suitable fixing bolts, taking into account wall type and unit weight (see table 1).

**Step 1.** Refer to Figure 1 for mounting details and drill the wall accordingly.

**Step 2.** Screw in the top bolts leaving a small gap between the head and the wall; lower the unit onto the bolts via key hole slots in the top of the wall brackets and then screw in the bottom bolts.

**Step 3.** Ensure all fixing bolts are tightened to stop the unit being lifted off the wall.



### Ceiling Suspension

6mm threaded inserts are provided in the top face of the casing (4 x M6 on the 1m and 6 x M6 on the 1.5/2m models, for dimensions see Figure 1) allowing the unit to be suspended on threaded rod (threaded rod is not provided). Ensure each of the threaded rods are secured on to a suitable structure that can support the weight of the unit (for unit weights see Table 1)\*. When fitting the threaded rod ensure that it does not interfere with internal components. Fit locking nuts (not supplied) and ensure they are engaged by a minimum of 20mm to stop the threaded rod rotating and coming away from the casing.

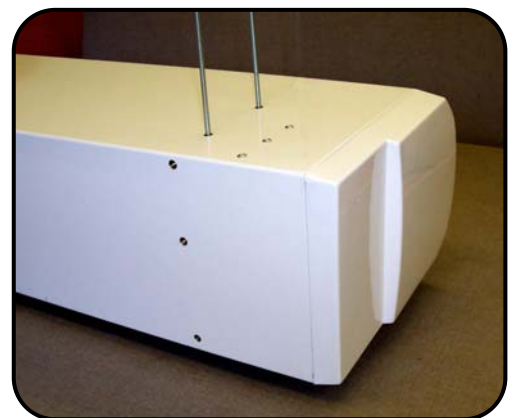

\*Please note it is the sole responsibility of the installer to ensure that the fixing points and bolts used are suitable for the air curtain being installed.

**Figure 1**

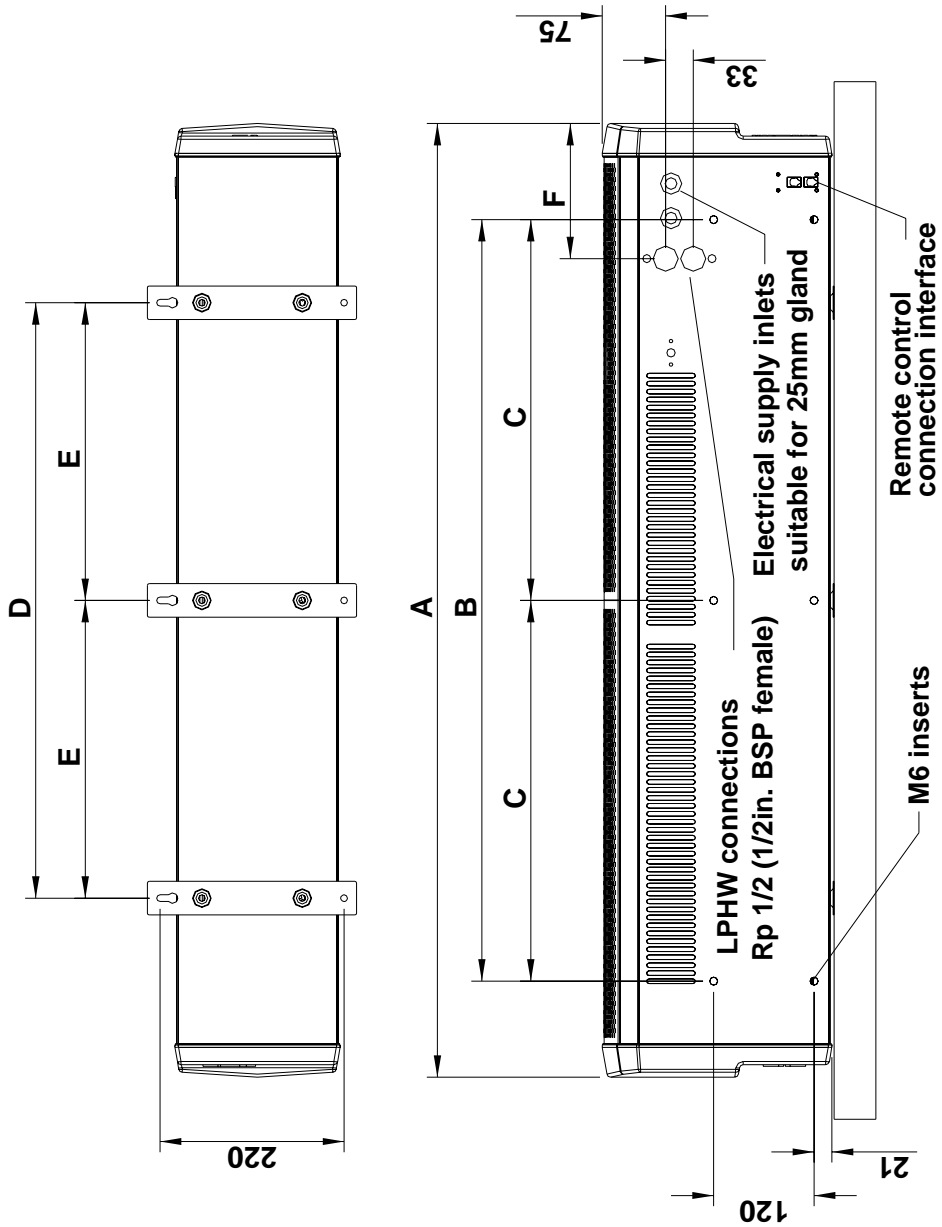

	C1000	C1500	C2000
A(mm)	1137	1669	2200
B(mm)	908	1408	1928
C(mm)	N/A	704	964
D(mm)	710	1208	1728
E(mm)	N/A	604	864
F(mm)	161	170	161

## ■ Safety and Electrical Connections

**All electrical wiring and connections MUST be carried out by a competent qualified electrician in accordance with the latest edition of the IEE wiring regulations and/or local statutory regulations.**

- A single phase or 3 phase local isolator with a contact separation of at least 3mm in all poles must be fitted to the supply wiring (the isolator must be fitted within an accessible position).
- The air curtain must be earthed.
- The appliance must be connected by means of wires having an appropriate temperature rating (heat resistant) (electric models only).
- Ensure that the supply cables, circuit breakers and other electrical installation equipment are correctly sized for the air curtain being installed; see Table 1 for Power Ratings. See also data badge on the left hand side of unit under end cap.
- On a 3 phase electrical supply the unit requires a neutral connection (3N~).
- Cable glands used for the Electrical Input must be rated IP21 or higher.

**Table 1**

Air Curtain	Electrical Supply (V/ph/Hz)	Rated Power Input (kW)	Current per phase (A)	Heat Output (kW)	Weight (kg)
C1000A	230/1/50	0.15	0.7	N/A	15
C1500A	230/1/50	0.20	0.9	N/A	21
C2000A	230/1/50	0.25	1.1	N/A	31
C1000W	230/1/50	0.15	0.7	6.0	16
C1500W	230/1/50	0.20	0.9	9.0	23
C2000W	230/1/50	0.25	1.1	12.0	33
C1000E	400/3/50	9.15	13.7	4.5/9.0	18
C1500E	400/3/50	12.20	18.3	6.0/12.0	26
C2000E	400/3/50	18.25	27.2	9.0/18.0	37

- To gain access to the electrical connections the air intake grilles must be removed. Ensure electrical mains supply to the unit is isolated. If end caps are already fitted, remove them from the air curtain first (see insert).

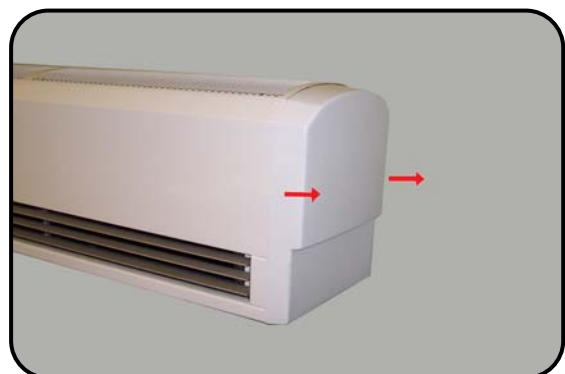

Two air inlet grilles are fitted on 1m, three on 1.5m and four on 2.0m models.

Remove intake grilles by unfastening two screws on each grille; M4 x 10mm Pozi No.2 screws accessed via larger hole in the bottom of the grille (see adjacent figure).

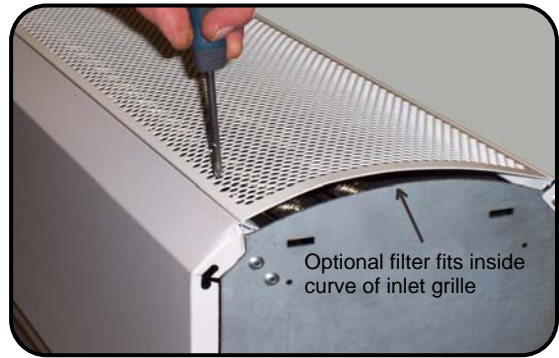

Access can now be gained to make the electrical connections. Once connections have been completed the inlet grilles should be refitted and if fitted the end caps clipped into place (see insert).



*Please note the panels of the air curtain are coated in a protective film which should be removed before use.*

#### ■ LPHW Models

For LPHW models ensure suitable water mains isolation valves are fitted in the flow and return pipework.

When fitting the 3-port valve ensure that the pipe connections are fitted as detailed below and are in accordance with the manufacturers leaflet supplied with the valve.

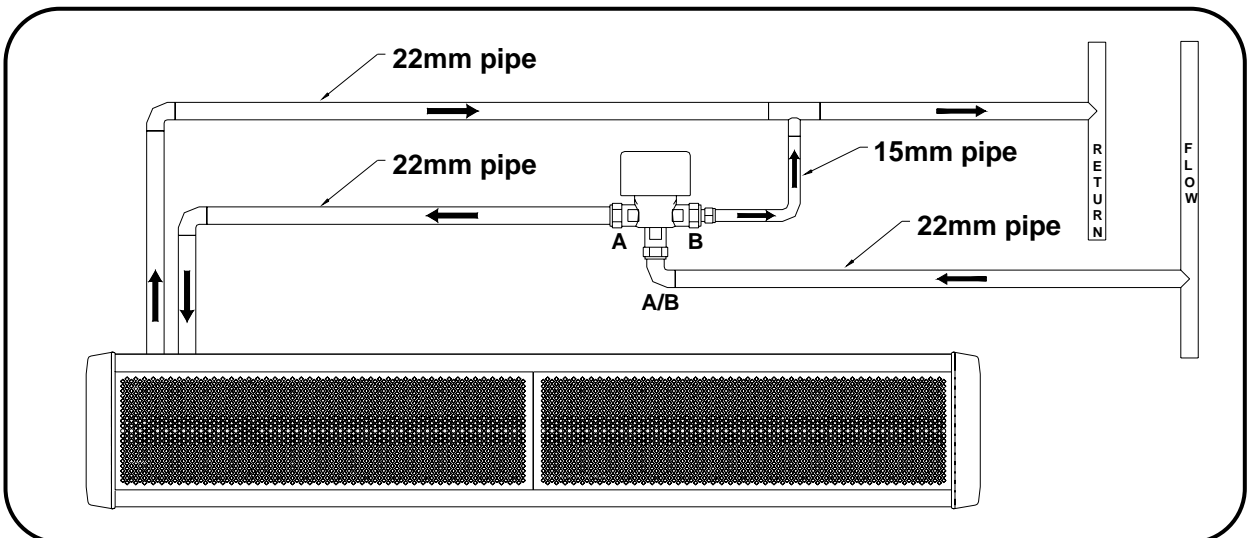

Air Curtain	Water Flow Rate (l/s) 82/72°C	Coil Water Pressure Drop (kPa)
C1000W	0.14	2.77
C1500W	0.21	6.74
C2000W	0.29	13.40

## ■ Ambient Models

Ambient units are supplied with a remote switch unit. The switch unit allows the air curtain to be powered ON/OFF and select one of three fan speeds.



## ■ Multiple Installation (Ecopower only)

To Master/Slave two or more air curtains together a suitable RJ lead should be connected from the Master to the Slave unit. Thermoscreens 3.0m RJ extension leads must be ordered separately. Additional air curtains, up to a maximum of eight units, may be connected as indicated below. For Master/Slave configuration an independent mains supply must be supplied to each air curtain.

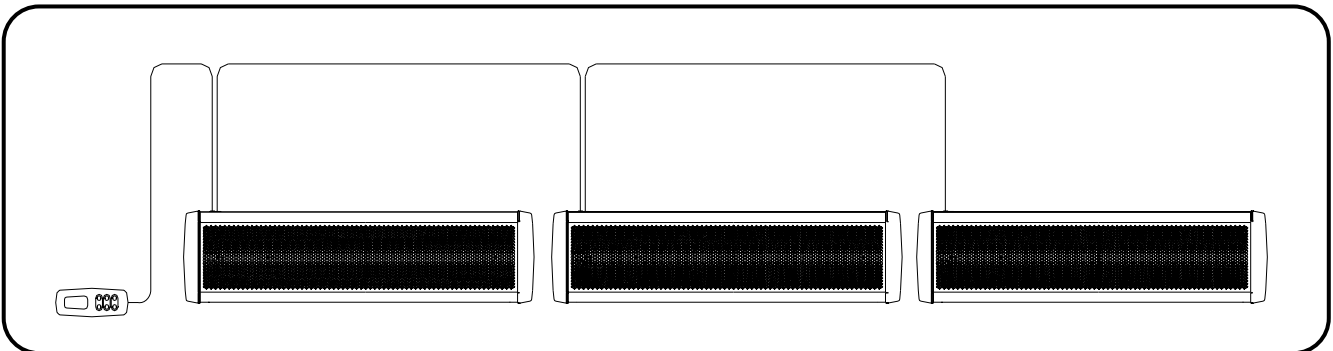

## ■ Fitting/Connecting the Remote Control (excluding Ambient)

The remote control unit should be located in a suitable place for easy access, it can be fixed to the wall via two key-hole slots. Drill and fix the screws into the wall leaving a small gap between the head and the wall, lower the unit onto the screws, for fixing centres see adjacent figure. Ensure suitable fixing screws are used.

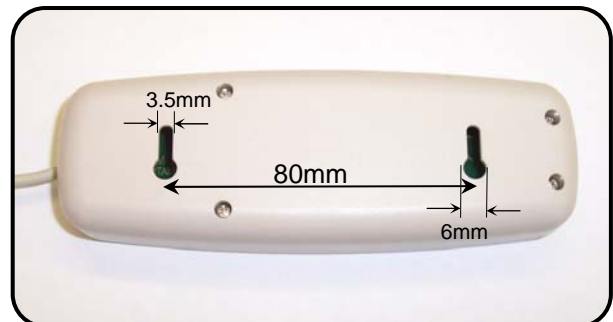



The remote control is supplied with 3m of cable and a pre-fitted RJ connecting plug.

Ensure the remote control cable is safely secured and connected to the top of the air curtain as indicated. It can be plugged into either socket.

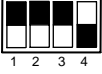

## Ecopower Controller Motherboard (v8)

Function	Control	Comments	Standard
<b>Fan Heat Interlock –</b> The heat output is dependent on the fan speed. If low or medium fan speed is selected the heat output can only go up to first heat stage. Only if the unit is operating on high fan speed can the second heat stage be selected. This feature operates in manual or auto mode.	DIP1 Option ON OFF  1 2 3 4	Suitable on vertical electrically heated Designer air curtain. Maximum heat output achieved if maximum fan speed selected. Independently set-up DIP switch on each mother board.	As supplied, the default setting would be for heat and fan settings to be independent (DIP1 OFF).
<b>Disable Fan Run-on –</b> Disable fan run-on.	DIP2 Option (LPHW & Ambient only) ON OFF  1 2 3 4	Must only be used for LPHW and Ambient air curtains. Independently set-up DIP switch on each mother board.	As supplied, the default setting would enable fan run-on (DIP2 OFF).
<b>Thermostat Master –</b> Only the air sensor thermistor in the master air curtain will be used for measuring the reference air temperature for the whole master/slave installation.	DIP3 Option ON OFF  1 2 3 4	The air sensor thermistors in all the slave air curtains will be ignored. This will then avoid situations on larger doorways with master/slave air curtains where some units can blow cold air whilst others can blow warm air, because they currently all refer to their own air sensor for control of the heat output of each air curtain. The master air curtain need not be the one that the wall control is plugged into. This dip switch setting must also be used for Global Switching (Master/Slave) via the INHIBIT terminal – see next page.	As supplied, the default setting would be for the air sensor thermistor on all units to be measuring (DIP3 OFF).
<b>Overheat Fan Disable –</b> If DIP4 is on and thermal overheat trips, heat and fan circuits are isolated and LED's on wall switch flash. If DIP4 is off and TOC trips out, only the heat circuit is isolated and the LED's on the wall switch flash.	DIP4 Option (Electric only) ON OFF  1 2 3 4	<b>Wall switch upgrade required.</b> The handset has to be powered on. Independently set-up DIP switch on each mother board.  <i>To remove fault, isolate electrical supply to air curtain, reset TOC and reconnect supply.</i>	As supplied, the default setting would enable fan if TOC trips (DIP4 OFF). <i>NB: If TOC operates with an upgraded switch the LED's on switch flash, regardless of DIP4 settings.</i>
<b>Retain User Settings (toggle) –</b> If electrical supply to the air curtain is removed, upon restoring electrical supply the customer's settings on the remote control will be retained, i.e. if unit were operating beforehand, it would automatically start up again and operate on the exact same settings as before.	Optional feature –via secret key press (Fan-down)	<b>Wall switch upgrade required</b>  <i>To toggle – switch unit on from handset. Hold Auto button till Auto LED flashes. Press fan down button to toggle selection.</i>	As supplied, the default setting would be for the unit to start up again automatically. Need to do the secret key presses to revert back to “nothing happens” when power is restored, as we have it now.
Fan run-on time set two minutes.	Built-in	If “FAN ONLY” has been selected, at switch off, no fan run-on.	
Reduce time for fan speeds to turn on and index up through Low, Medium and High fan speed when turning on via the BMS/Remote On/Off option.	Built-in	This feature to operate on slave units as well.	

 - white rectangle indicates the moveable head of each 4 way DIP switch

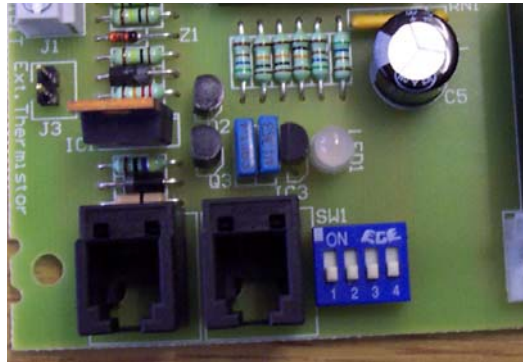

DIP switches fitted on the Ecopower board provide a selection of optional features as described above. Isolate and switch electrical power off before configuring and/or changing any DIP switch settings.

- Easy plug-in arrangement for remote air sensor thermistor on a 1m lead. Plugging-in the remote air sensor to J3 disables the standard air sensor thermistor already fitted on the Ecopower board. As supplied, the board will not have the remote air sensor fitted.

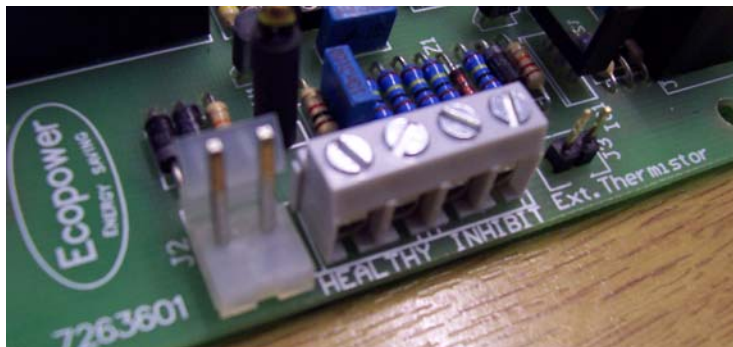

- An INHIBIT two screw terminal fitted on the Ecopower board for BMS remote On/Off feature. If the terminal is linked, i.e. by 2 wires to a remote volt free contact, the unit will run. If it is open circuit across the terminal the unit will switch off. This remote On/Off feature has global switching logic, i.e. if you master/slave several units together you need connect the remote contact to only one of them to turn all units on and off in the master/slave system. For global switching to work on the slave units, need to set DIP3 Option (see previous page) on the unit that the remote contact is wired to and have previously turned the unit on with the wall switch. As supplied, a wire link will be fitted to the terminal block on every unit. For summer settings place a 3.3kΩ resistance across the INHIBIT terminal, with these settings fans only will run even if controller is requesting for heat.

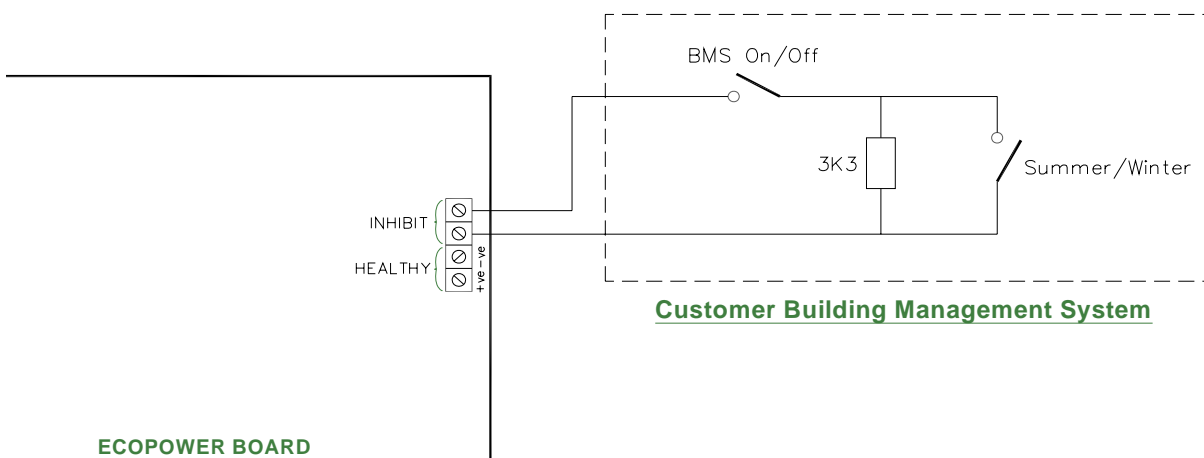

- A HEALTHY two screw terminal is included on the board for a fault signal indication if the electric elements overheat cut-out has operated. A healthy system provides a 24V DC signal at the terminals compared to an overheat fault which provides 0V DC.



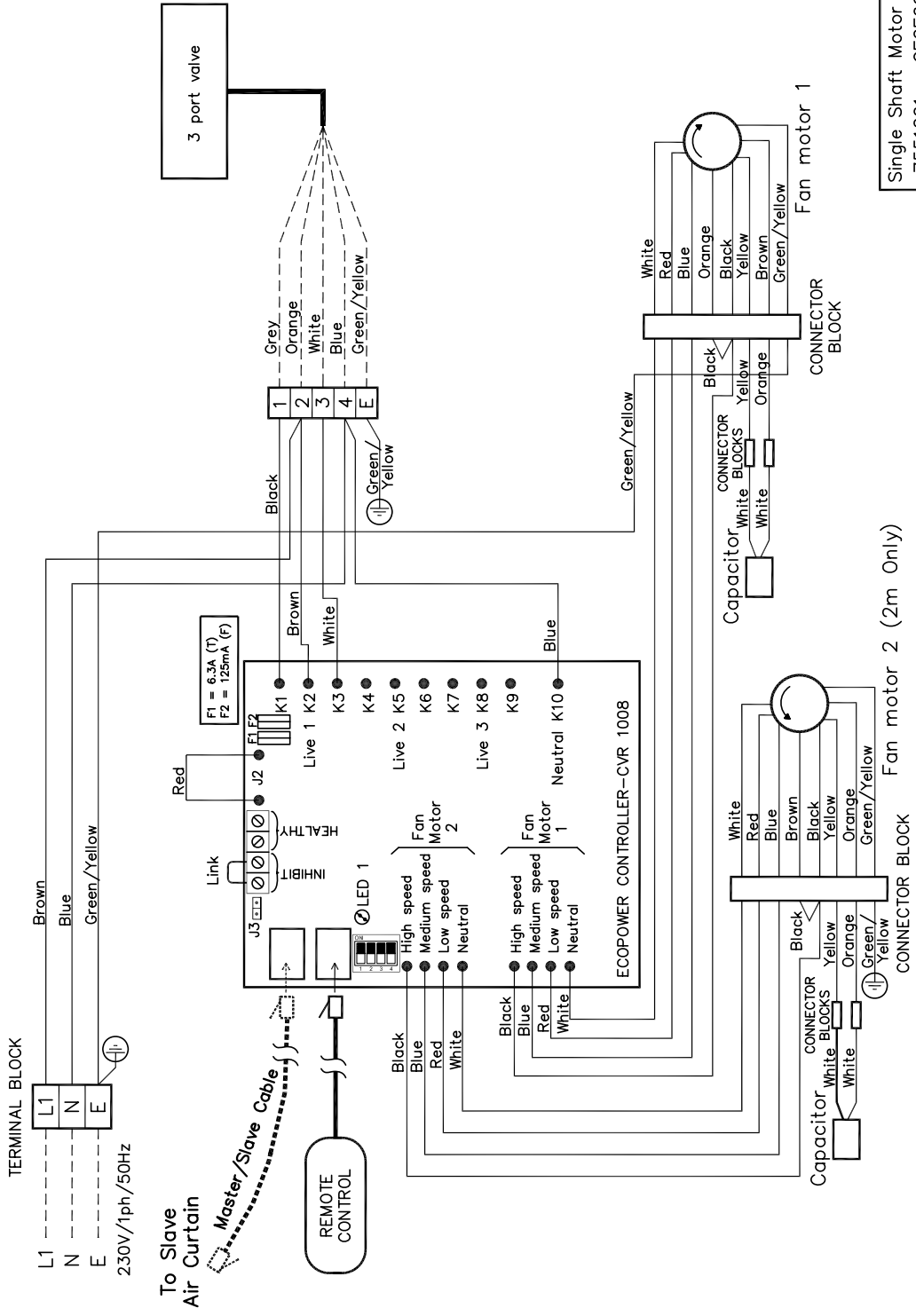

Single Shaft Motor for C range	
7551201	CE2E6694K (1m) - 3µF
7551201	CE2E6694K (1.5m) - 4µF
7551201	CE2E6694K (2m) - 3µF (x2)

## C1000W, C1500W AND C2000W + ECOPOWER

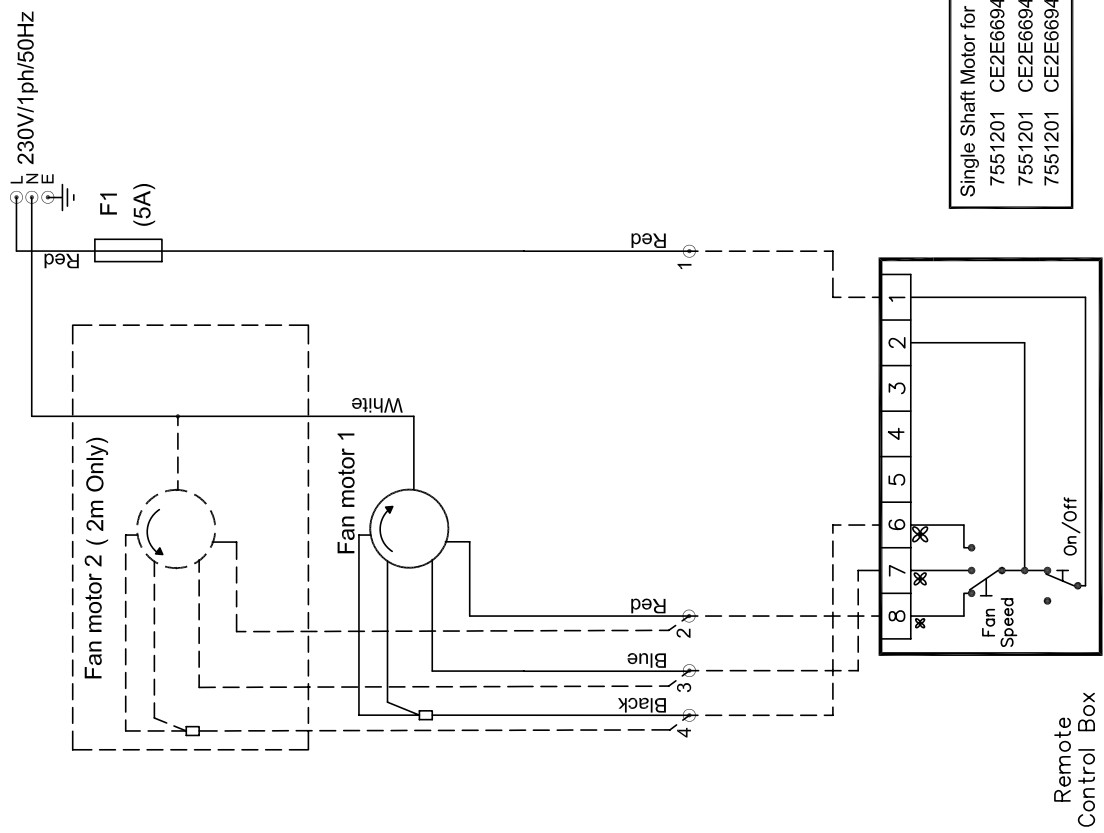

Single Shaft Motor for C range

7551201	CE2E6694K (1m)	- 3μF
7551201	CE2E6694K (1.5m)	- 4μF
7551201	CE2E6694K (2m)	- 3μF (x2)

Remote Control Box

## C1000A, C1500A AND C2000A

## Ecopower Remote Control Operation

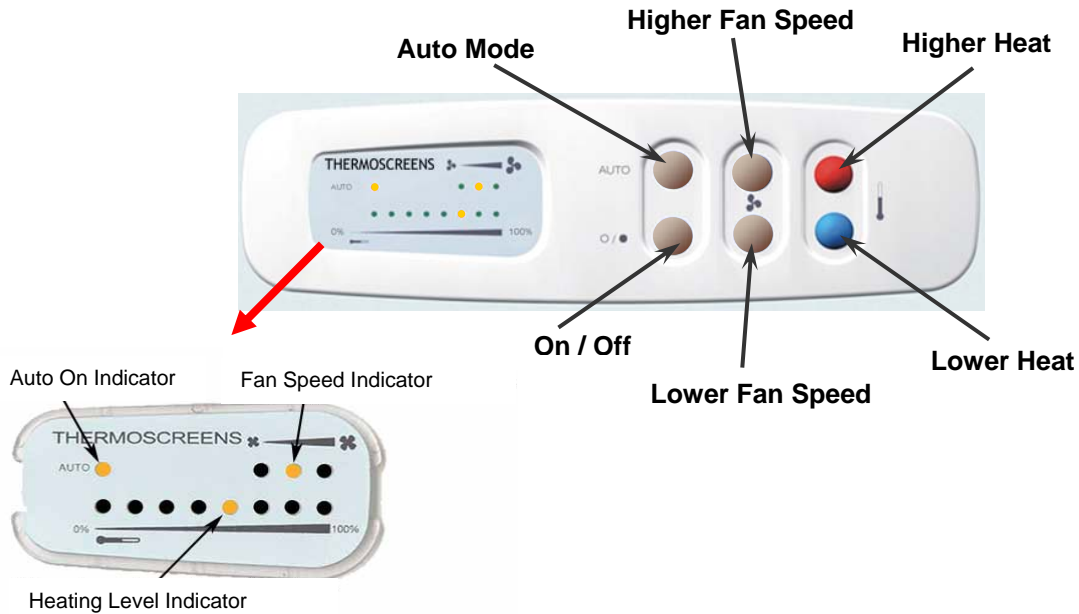

### Push On/Off switch to turn On, then operate as follows :-

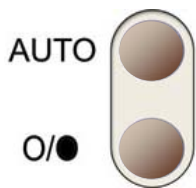

**Auto** Switches between manual and automatic heat regulation. The Auto on indicator LED is lit for "Auto Mode" and un-lit for "Manual Mode".

**On/Off** Turns the air curtain On or Off (when turned off the settings for heat and fan speed are retained). If the air curtain is heating when it is turned off with this switch the fan will run-on for a time (approx. 2 minute) to dissipate excess heat.

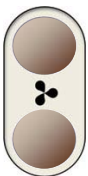

Selects the appropriate fan speed (Low, Medium or High) to suit the air curtain height and outside wind conditions. Fan speed can be changed when unit is in either Auto or Manual Modes. A fan speed indicator LED shows which fan speed is selected.

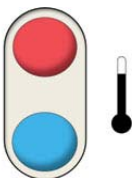

In "Auto Mode" the air curtain measures the incoming air temperature and automatically selects the necessary amount of heat to keep it at the level selected. Heating level indicator LED's go from 0% to 100% in 8 steps to show the level selected.

In "Manual Mode" heat output can be selected as Zero, Half Heat or Full Heat. Heating level indicator LED's go 0%, 50% or 100% to show the level selected.

### Push On/Off switch again to turn Off

**Note** If the mains supply is isolated or cuts-out during operation the On/Off switch will need to be pushed again to start the air curtain when the mains supply is restored. The safety thermal cut-out in the air curtain may operate, if this happens it will need to be reset by a competent technician.

## Commissioning

Set the discharge grille vanes so they point straight downwards over the doorway. Once the air curtain is functioning check that the fans operate at Low, Medium and High speeds, that there is no excessive mechanical noise coming from the fans and that all fans are working. If the unit is electric heated or water heated check that the air stream from the discharge grille warms up across the whole length of the air curtain when heating is selected. Check that heating increases as higher heat is selected and feel to see that the warm air stream is reaching across the doorway with door open or closed. If necessary the vanes of the discharge grille can be angled either inwards or outwards if this gives better penetration/warming of any incoming draughts. If an Ecopower controller is being used check its operation in Manual Mode. Then select Auto Mode and increase the heating set point until the air stream warms up. Reduce the heating set point until the air stream goes cold.

Before leaving site it is important that the air curtain installation is “Handed-Over” to the end user or his representative and the operation of it is fully explained and that they understand how it operates. Explain also the service intervals and that the unit must be regularly cleaned and if it has filters fitted that these require regular cleaning/replacement.

## Fault Conditions

In the event of a fault the thermal cut out(s) (*Note: If the mains supply is isolated during operation then the thermal cut outs may operate*) or internal fuses may operate. The thermal cut out(s) are located on the top face of the unit directly above the element banks (one on the 1 & 1.5m and two on the 2m model). For Ecopower units the internal fuses are located on the PCB. For Ambient and Standard LPHW units the fuse is located within the control panel at the left hand end of the air curtain.

In the case of a fault condition (refer to flowchart) do not attempt to reset the thermal cut outs or replace the fuses, arrange for a Thermoscreens appointed technician or certified electrician to attend the unit to investigate the reason why the thermal cut outs/fuse(s) have operated. Once the cause has been determined and rectified, they will reset/replace the thermal cut out/fuse and function test the unit.

## PCB Status

Fitted on the PCB board inside of the air curtain is an LED shown as LED1 on wiring diagrams that will indicate the Ecopower control status.

1. LED flashing green – operation normal.
2. LED flashing red – low supply voltage.
3. LED permanently red – thermal cut outs open circuit (electrically heated models only).

Note to reset the thermal cut outs please refer to fault condition section detailed above.

## 🚧 User Fault Finding Flowchart (for Ecopower Control)

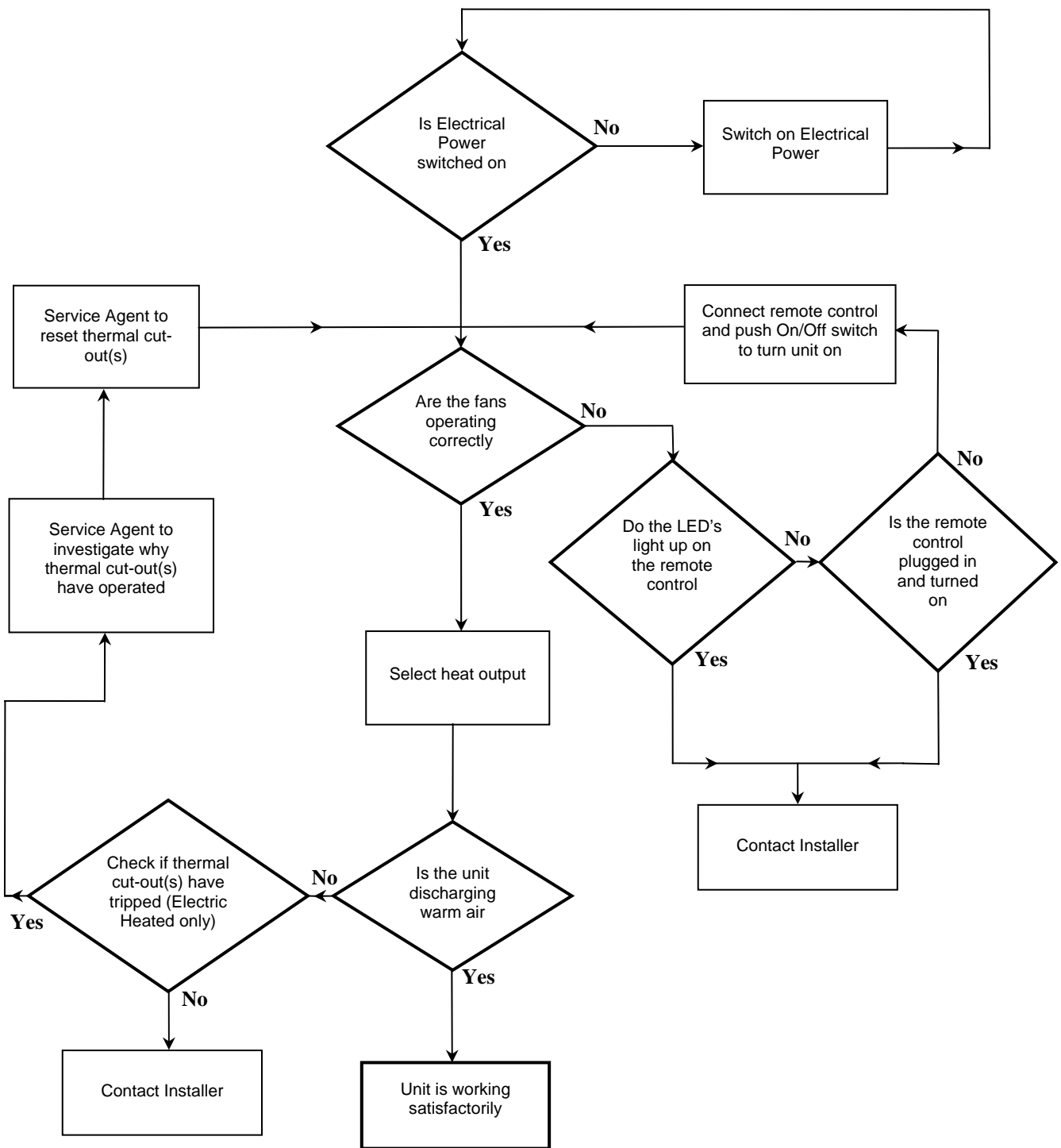

## Service & Maintenance

**Always disconnect and isolate the mains electricity supply before installing, maintaining or repairing this equipment. Note: All maintenance/repairs should only be carried out by a competent electrician or Thermoscreens appointed technician.**

Once the mains supply is isolated, remove end caps from the air curtain (if fitted). Remove each air intake grille by unfastening two screws on each grille - M4 x 10mm Pozi No.2 screws accessed via the larger hole at the bottom of each grille.

To ensure the air curtain operates at full efficiency the inlet/outlet grilles, fan impellers, housings and motors must be kept free of dust and debris. Build up of dust on the fan impellers can cause vibration, noise and excessive wear on the motor bearings.

Frequency of cleaning will depend on the environment, but we would recommend that the unit be cleaned a minimum of every 3 months (failure to adequately maintain the unit and provide a suitable cleaning schedule will result in performance degradation and reduce the life expectancy of the air-curtain).

Vacuum and clean the build-up of dirt and debris within the air-curtain (*please note that the motor(s) are permanently lubricated and require no additional lubrication*). *If filters are fitted, ensure these are regularly inspected and cleaned or replaced. All dirty or blocked filters should be immediately replaced.*

Once the air curtain has been cleaned check all electrical connections within the unit ensuring terminals are tight and that crimped connections have not become loose. Refit inlet grilles and end caps. Reconnect the electrical supply and fully function test the air-curtain to ensure correct operation (See Commissioning).

If the outer casing requires cleaning this should be done using a warm soft cloth. Do not use solvents or abrasive materials.

## Warranty

If any problems are encountered, please contact your installer/supplier. Failing this please contact the Thermoscreens warranty department. All units are covered by a two year warranty period.

Care has been taken in compiling these instructions to ensure they are correct, although Thermoscreens disclaims all liability for damage resulting from any inaccuracies and/or deficiencies in this documentation. Thermoscreens retain the right to change the specifications stated in these instructions.

Thermoscreens Ltd  
St. Mary's Road Nuneaton  
Warwickshire England  
CV11 5AU

Email: [sales@thermoscreens.com](mailto:sales@thermoscreens.com)

Tel: + 44 (0) 24 7638 4646

Fax: + 44 (0) 24 7638 8578

[www.thermoscreens.com](http://www.thermoscreens.com)