



thermoscreens®

PHV-RECESSED RANGE AIR CURTAINS

INSTALLATION, OPERATION & MAINTENANCE INSTRUCTIONS



Ecopower
Energy Saving

PLEASE READ THESE INSTRUCTIONS CAREFULLY BEFORE ATTEMPTING INSTALLATION

Thermoscreens Ltd
St. Mary's Road Nuneaton
Warwickshire England
CV11 5AU

Email: sales@thermoscreens.com

Tel: +44 (0) 24 7638 4646

Fax: +44 (0) 24 7638 8578

www.thermoscreens.com

UK

UN-PACKING YOUR PHV-RECESSED AIR-CURTAIN

The following items are supplied and packaged within the boxes.

PHV-Recessed Air Curtain



Remote Control

Ecopower
Electric & LPHW



Manual Ambient



Motorised Valve (Ecopower LPHW units only)



Recessed Grille (Packed separately)



Note Optional filters are available for Water and Ambient models.

If anything is missing or damaged please contact your place of purchase immediately.

For your records

Date of Purchase.....
Place of Purchase.....
Serial Number.....

For warranty purposes proof of purchase is necessary so please keep a copy of your invoice.

(All documentation supplied with each unit should be stored and kept for future reference).

INSTALLATION OF YOUR PHV-RECESSED AIR-CURTAIN

The PHV-Recessed air curtain has been designed for recessing within ceiling voids or bulkheads.

Location

Ensure that the unit is mounted within its height specification of 1.8m to 3.75m maximum (from floor level to the underside of the unit/grille) and that it is situated as close to the door as possible. Note: The air discharge should be nearest to the door as shown in adjacent figure. Ensure the air curtain is as close to the door opening as possible for best performance, obstructions such as door opening devices, structural beams etc will reduce the performance.

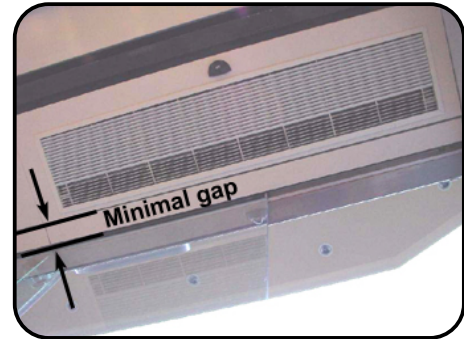

Note the PHV-Recessed air curtain has a series of square punched air ventilation holes along one side panel of the unit which will be within the ceiling void once the unit is installed. There must be an air gap of 50mm minimum between these ventilation holes and any obstruction/bulkhead within the ceiling void to allow ventilation air to easily enter the air curtain via these holes. Furthermore, the ceiling void must be sufficiently large and freely ventilated so there will be adequate supply of ventilation air (m³/hr) to the unit, see Table 1. If the ceiling void is enclosed around the air curtain it will need an air ventilation grille of effective free area (cm²) as given in Table 1 and an adequate air path within the void for air to enter the square punched air ventilation holes.

Table 1

Air curtain	Required air flow within ceiling void (m ³ /hr)	Effective free area of ventilation grille for an enclosed ceiling void (cm ²)
PHV1000R	353	500
PHV1500R	421	700
PHV2000R	707	1200

Ceiling Suspension

For a standard width recess grille (436mm), make the cut-out in the ceiling to the dimensions given in Figure 1. The air curtain needs to be tipped on its side and angled upwards to fit through the ceiling cut-out, ensure there is sufficient height clearance in the ceiling void to do this. For an air curtain with a wider recess grille (476mm), make the cut-out in ceiling to the dimensions given in Figure 2. The air curtain will fit through the ceiling cut-out. Alternatively, the ceiling can be fitted after the air curtain has been installed.

Clearance holes for M10 threaded rod to enter from above are provided on the top face of the casing (4 x 1m and 6 x 1.5/2m models, for dimensions see Figure 1 or Figure 2) allowing the unit to be suspended. All six suspension points **must** be used for 1.5m and 2m models.

Insert rod through each hole in top and attach onto each fixing bracket at lower edge of air curtain (see insert). Lock rod in place using M10 nut above and below fixing bracket (threaded rod and locking nuts are not provided). Ensure rod does not come below bottom face of unit.

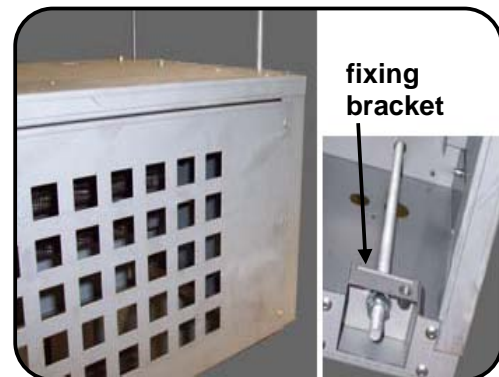

Ensure each of the threaded rods is secured on to a suitable structure that can support the weight of the unit (for unit weights see Table 2)*.

Figure 1 - Standard Recess Grille

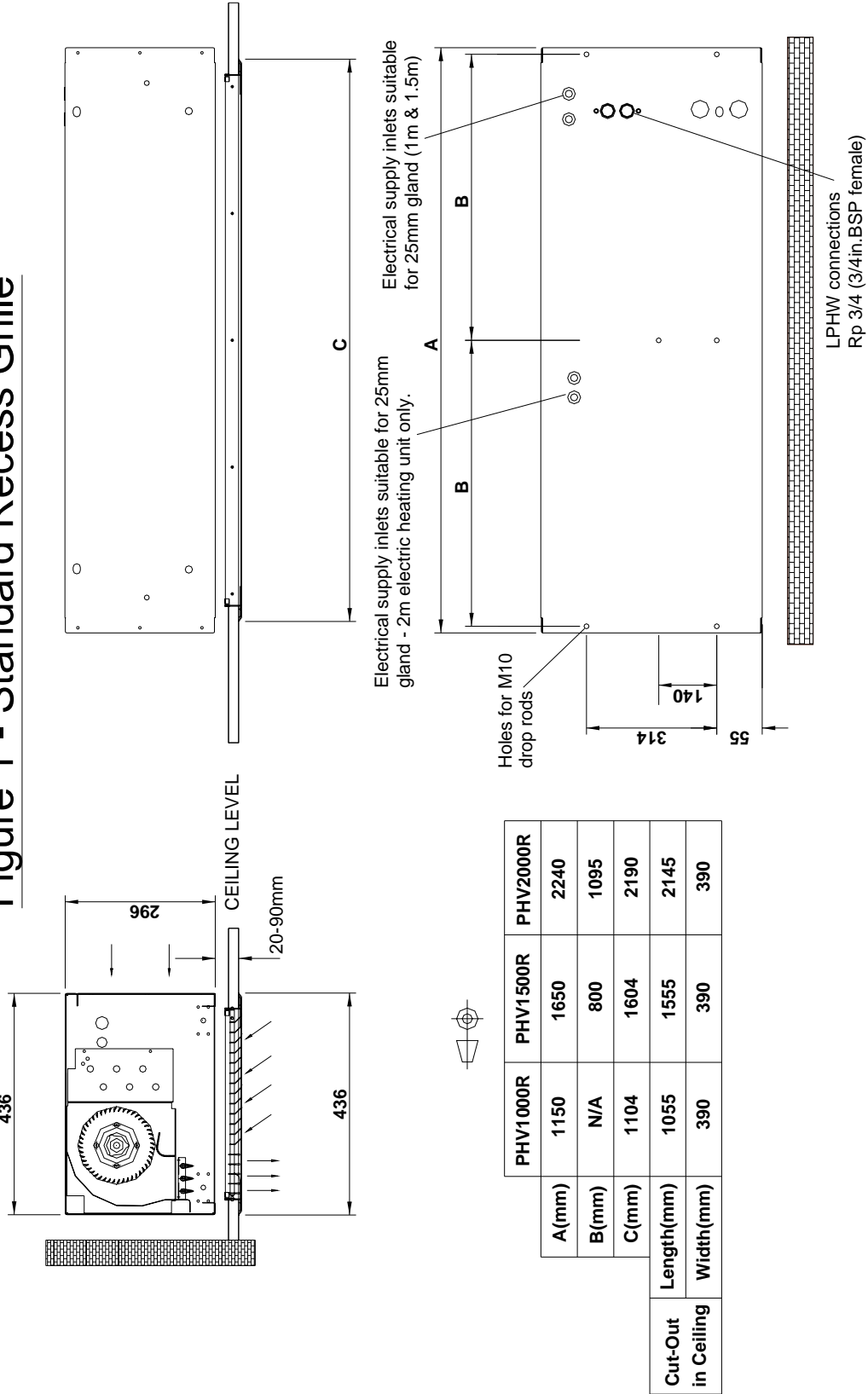

	PHV1000R	PHV1500R	PHV2000R
A(mm)	1150	1650	2240
B(mm)	N/A	800	1095
C(mm)	1104	1604	2190
Length(mm)	1055	1555	2145
Width(mm)	390	390	390

Figure 2 - Wider Recess Grille

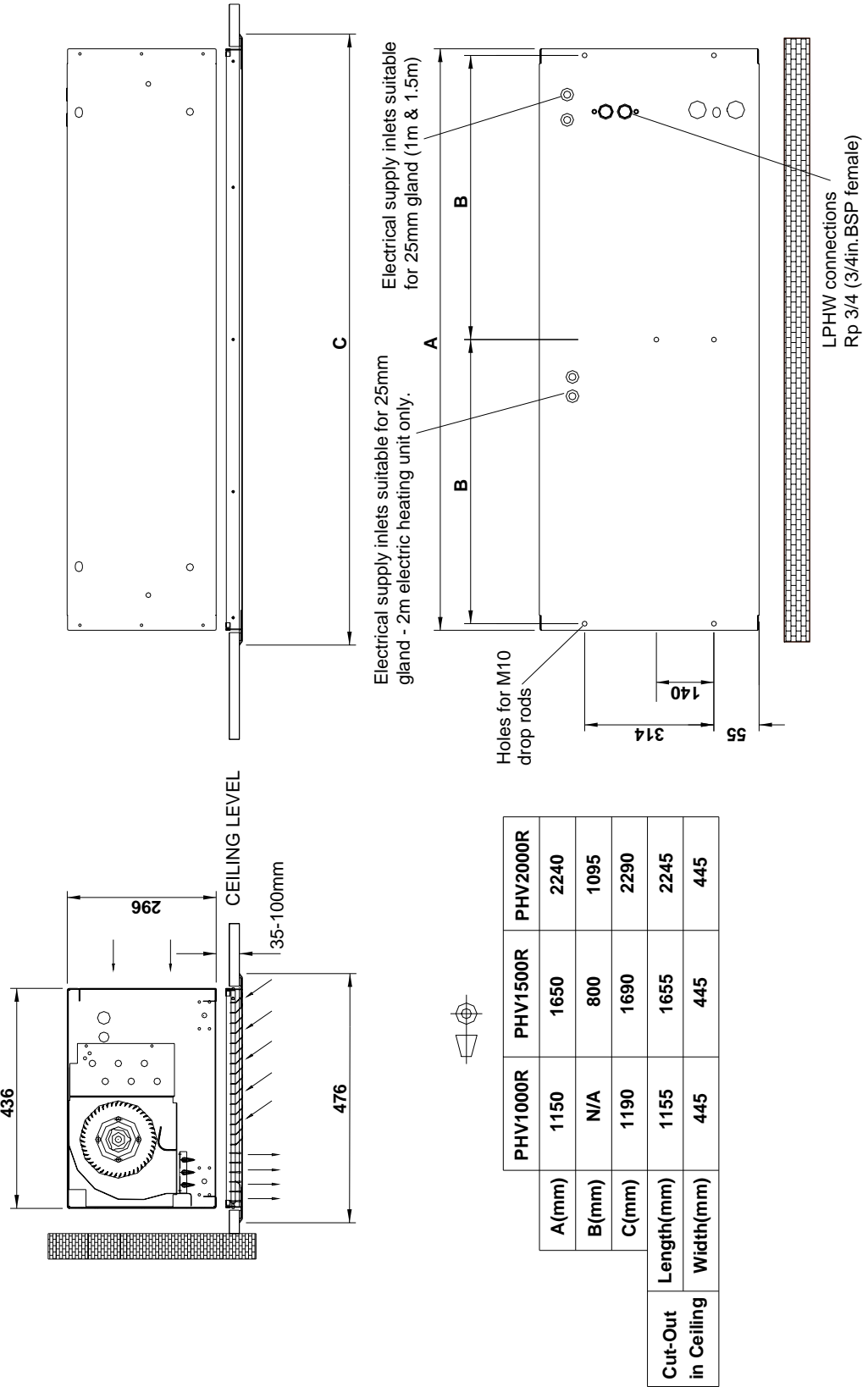

	PHV1000R	PHV1500R	PHV2000R
A(mm)	1150	1650	2240
B(mm)	N/A	800	1095
C(mm)	1190	1690	2290
Length(mm)	1155	1655	2245
Width(mm)	445	445	445

Note: When installing the air curtain ensure that the underside of the unit is 50mm above the bottom face of the ceiling tile/plasterboard. The recessed grille has an adjustment range from the underside of the air curtain to the exposed bottom face of the ceiling tile/plasterboard (see Figure 1 or Figure 2).

*It is the sole responsibility of the installer to ensure that the building fixing points and suspension system used are suitable for the air curtain being installed

⚠ Safety and Electrical Connections

All electrical wiring and connections MUST be carried out by a competent qualified electrician in accordance with the latest edition of the IEE wiring regulations and/or local statutory regulations.

- A single phase or 3 phase local isolator with a contact separation of at least 3mm in all poles must be fitted to the supply wiring (the isolator must be fitted in an accessible position).
- The air curtain must be earthed.
- The appliance must be connected using cables having an appropriate temperature rating (heat resistant).
- Ensure that the supply cables, circuit breakers and other electrical installation equipment are correctly sized for the air curtain being installed; see Table 2.
- On a 3 phase electrical supply the unit requires a neutral connection (3N~).
- Cable glands used for the Electrical Input must be rated IP21 or higher.

Table 2

Air Curtain	Electrical Supply (V/ph/Hz)	Rated Power Input (kW)	Current per phase (A)	Heat Output (kW)	Weight (kg)
PHV1000AR	230/1/50	0.30	1.3	N/A	38
PHV1500AR	230/1/50	0.40	1.8	N/A	51
PHV2000AR	230/1/50	0.60	2.7	N/A	68
PHV1000WR	230/1/50	0.30	1.3	12.0	45
PHV1500WR	230/1/50	0.40	1.8	18.0	59
PHV2000WR	230/1/50	0.60	2.7	24.0	78
PHV1000ER	400/3/50	12.30	18.7	6.0/12.0	42
PHV1500ER	400/3/50	18.40	27.9	9.0/18.0	57
PHV2000ER	400/3/50	24.60	37.5	12.0/24.0	76

⚠ Fitting/Connecting the Ecopower Remote Control (excluding Ambient)

The remote control unit should be located in a suitable place for easy access, it can be fixed to the wall via two key-hole slots. Drill and fix the screws into the wall leaving a small gap between the head and the wall, lower the unit onto the screws, for fixing centres see adjacent figure. Ensure suitable fixing screws are used.

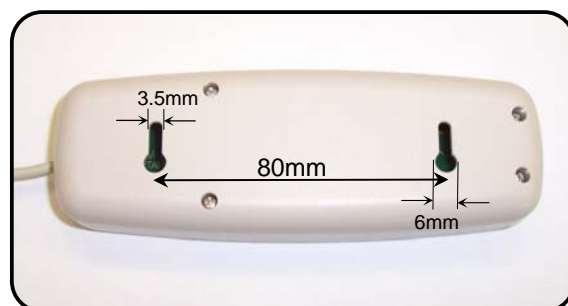

The remote control is supplied with 3m of cable and a pre-fitted RJ connecting plug. Ensure the remote control cable is safely secured and connected.

■ Fitting of the Recessed Grille

The grille consists of a frame, grille core (fitted within the frame) and four brackets (note: the brackets are fixed to the frame).

■ Removal of Grille Core

Prior to fitting the grille to the air curtain and the ceiling the grille core will need to be removed from its frame. Release the grille core by unfastening the two conical bolts fitted at each end of the grille core. Push against the spring loaded pins and the grille core can now be pulled clear of its frame.

Note: the grille core will still be attached to the frame via cord safety ties.

The rectangular hole in the ceiling must be sized to suit the grille frame, see Figure 1 or Figure 2 for dimensions.

■ Attaching the Grille to the Air Curtain

Before lifting the grille frame into position locate the four M6 bolts (two inside each end of the air curtain). Remove the M6 bolts and lift the frame into position (ensure that when fitted the air discharge vanes align with the air discharge of the air curtain, see Figure 1 or Figure 2), screw each M6 bolt through the slot in the grille bracket until all four are located into place. Adjust the height of the grille frame (via slots in brackets) so the frame fits nicely against the under side of the ceiling. Once the desired height is achieved tighten each M6 bolt in place locking the grille frame into the correct position.

■ Adjusting the Separator Plate

Within the air curtain there is a sliding separator plate, this needs adjusting up or down to stop the air discharge re-circulating within the air curtain. To adjust the separator plate release the M6 bolts at either end, extend the slide plate so that it will just touch the topside of the grille along its whole length and tighten the bolts. It will be necessary to fit the grille core to gauge where the separator plate should be fitted.

■ Fitting the Grille Core

Once the above is complete the grille core can be refitted, to do so locate each spring loaded pin in its locating hole, push against the spring loaded pins to allow the fixed pins to locate within their fixing holes. Tighten and secure the conical bolts fitted at each end of the grille core.

Once the ceiling is finished remove the protective plastic film from the recessed grille frame.

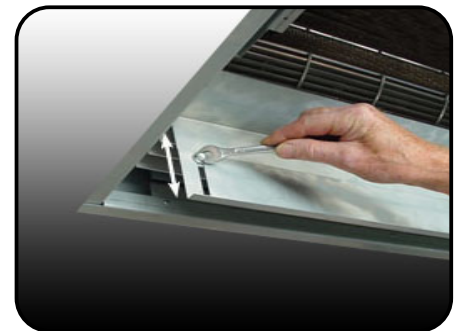
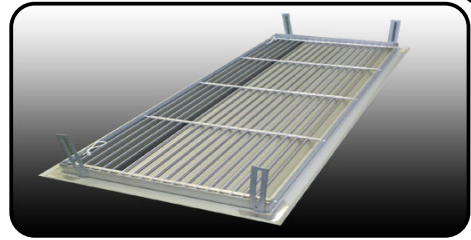

☒ LPHW Models

For LPHW models ensure suitable water mains isolation valves are fitted in the flow and return pipework.

When fitting the 3-port valve ensure that the pipe connections are fitted as detailed below and are in accordance with the manufacturers leaflet supplied with the valve.

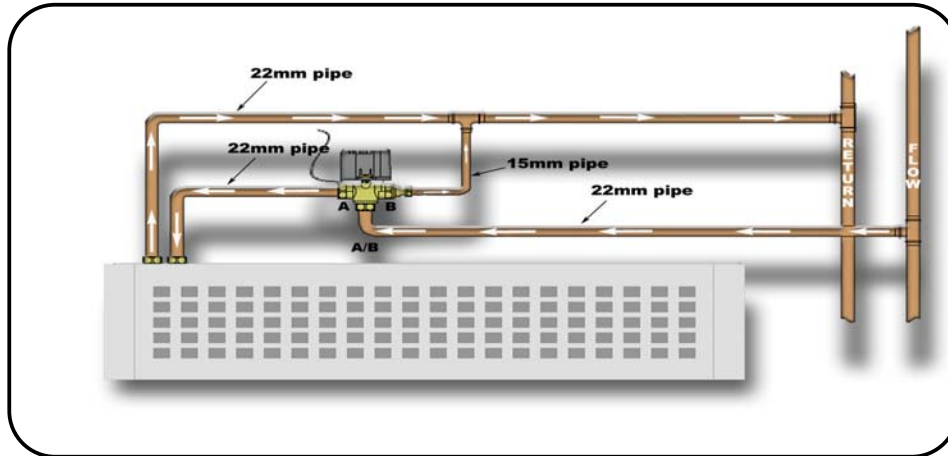

Air Curtain	Water Flow Rate (l/s) 82/72 °C	Coil Water Pressure Drop (kPa)
PHV1000WR	0.29	1.14
PHV1500WR	0.43	2.60
PHV2000WR	0.57	4.72

☒ Ambient Models

Ambient units are supplied with a remote switch unit. The switch unit allows the air curtain to be powered ON/OFF and select one of three fan speeds.



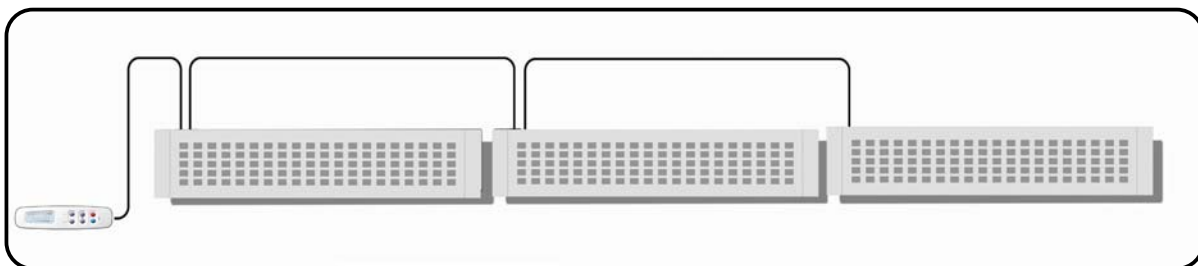

☒ Multiple Installation (Ecopower only)

To Master/Slave two or more air curtains together the remote control is plugged into the Master unit and a RJ extension lead should be connected from the Master to the Slave unit(s). Thermoscreens 3m RJ extension leads are available and must be ordered separately. Additional air curtains, up to a maximum of eight units, may be connected as indicated below. For Master/Slave configuration an independent mains supply as per Table 2 must be supplied to each air curtain.

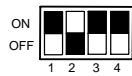

Ecopower Controller Motherboard (v8)

Function	Control	Comments	Standard
Fan Heat Interlock – The heat output is dependent on the fan speed. If low or medium fan speed is selected the heat output can only go up to first heat stage. Only if the unit is operating on high fan speed can the second heat stage be selected. This feature operates in manual or auto mode.	DIP1 Option 	Suitable on vertical electrically heated Designer air curtain. Maximum heat output achieved if maximum fan speed selected. Independently set-up DIP switch on each mother board.	As supplied, the default setting would be for heat and fan settings to be independent (DIP1 OFF).
Disable Fan Run-on – Disable fan run-on.	DIP2 Option (LPHW & Ambient only) 	Must only be used for LPHW and Ambient air curtains. Independently set-up DIP switch on each mother board.	As supplied, the default setting would enable fan run-on (DIP2 OFF).
Thermostat Master – Only the air sensor thermistor in the master air curtain will be used for measuring the reference air temperature for the whole master/slave installation.	DIP3 Option 	The air sensor thermistors in all the slave air curtains will be ignored. This will then avoid situations on larger doorways with master/slave air curtains where some units can blow cold air whilst others can blow warm air, because they currently all refer to their own air sensor for control of the heat output of each air curtain. The master air curtain need not be the one that the wall control is plugged into.	As supplied, the default setting would be for the air sensor thermistor on all units to be measuring (DIP3 OFF).
Overheat Fan Disable – If DIP4 is on and thermal overheat trips, heat and fan circuits are isolated and LED's on wall switch flash. If DIP4 is off and TOC trips out, only the heat circuit is isolated and the LED's on the wall switch flash.	DIP4 Option (Electric only) 	Wall switch upgrade required. The handset has to be powered on. Independently set-up DIP switch on each mother board. <i>To remove fault, isolate electrical supply to air curtain, reset TOC and reconnect supply.</i>	As supplied, the default setting would enable fan if TOC trips (DIP4 OFF). <i>NB: If TOC operates with an upgraded switch the LED's on switch flash, regardless of DIP4 settings.</i>
Retain User Settings (toggle) – If electrical supply to the air curtain is removed, upon restoring electrical supply the customer's settings on the remote control will be retained, i.e. if unit were operating beforehand, it would automatically start up again and operate on the exact same settings as before.	Optional feature –via secret key press (Fan-down)	Wall switch upgrade required. <i>To toggle – switch unit on from handset. Hold Auto button till Auto LED flashes. Press fan down button to toggle selection.</i>	As supplied, the default setting would be for the unit to start up again automatically. Need to do the secret key presses to revert back to “nothing happens” when power is restored, as we have it now.
Fan run-on time set two minutes.	Built-in	If “FAN ONLY” has been selected, at switch off, no fan run-on.	
Reduce time for fan speeds to turn on and index up through Low, Medium and High fan speed when turning on via the BMS/Remote On/Off option.	Built-in		

- white rectangle indicates the moveable head of each 4 way DIP switch

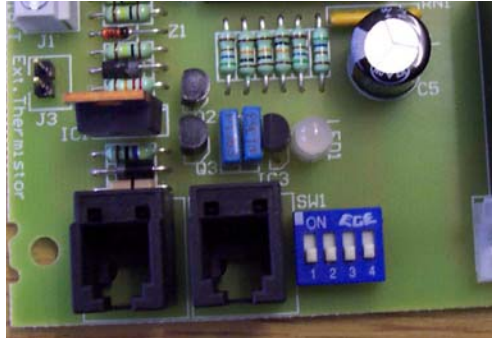

DIP switches fitted on the Ecopower board provide a selection of optional features as described above. Isolate and switch electrical power off before configuring and/or changing any DIP switch settings.

- Easy plug-in arrangement for remote air sensor thermistor on a 1m lead. Plugging-in the remote air sensor to J3 disables the standard air sensor thermistor already fitted on the Ecopower board. As supplied, the board will not have the remote air sensor fitted.

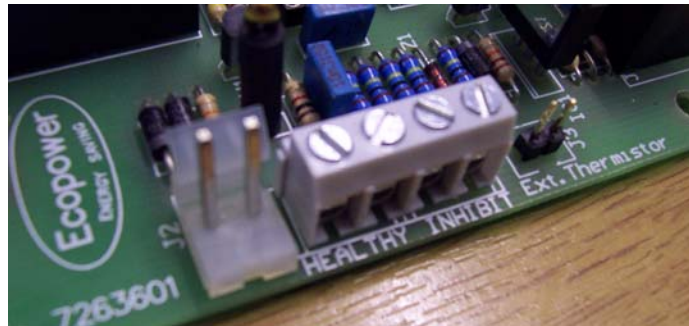

- An INHIBIT two screw terminal fitted on the Ecopower board for BMS remote On/Off feature. If the terminal is linked, i.e. by 2 wires to a remote volt free contact, the unit will run. If it is open circuit across the terminal the unit will switch off. This remote On/Off feature has global switching logic, i.e. if you master/slave several units together you need connect the remote contact to only one of them to turn all units on and off in the master/slave system. As supplied, a wire link will be fitted to the terminal block on every unit. For summer settings place a 3.3k Ω resistance across the INHIBIT terminal, with these settings fans only will run even if controller is requesting for heat.

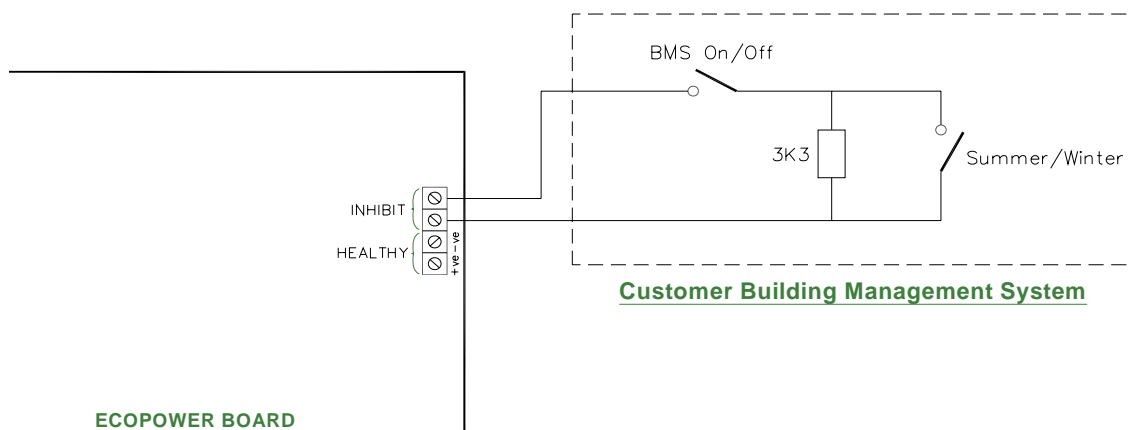

- A HEALTHY two screw terminal is included on the board for a fault signal indication if the electric elements overheat cut-out has operated. A healthy system provides a 24V DC signal at the terminals compared to an overheat fault which provides 0V DC.

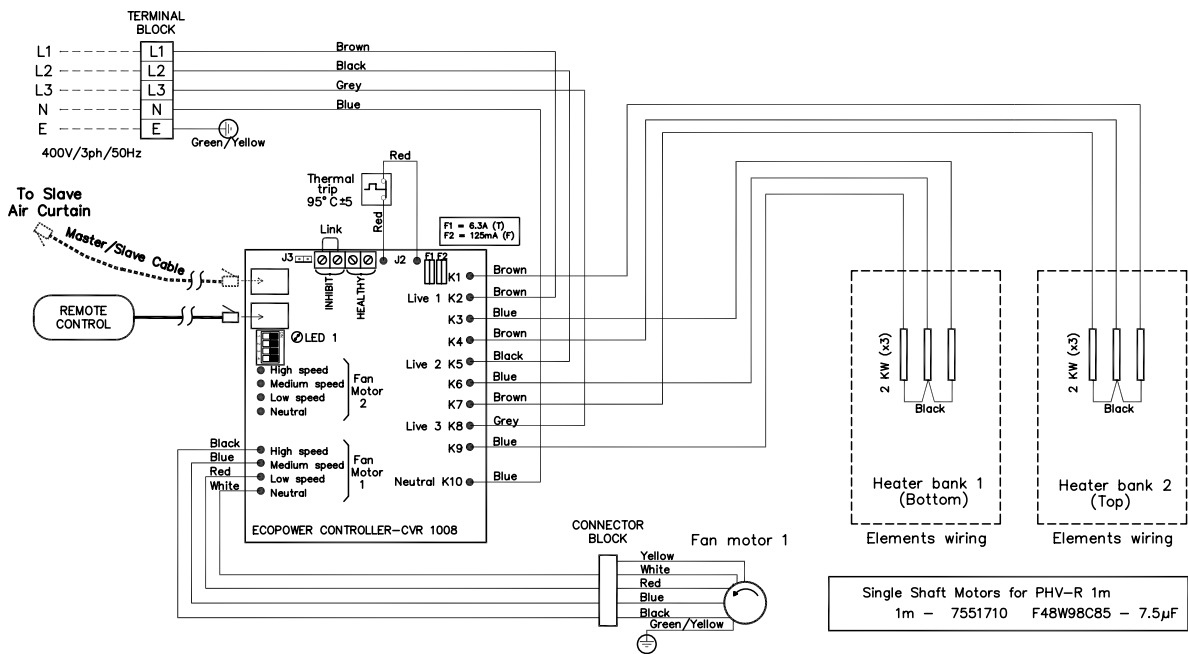

PHV1000ER + ECOPOWER

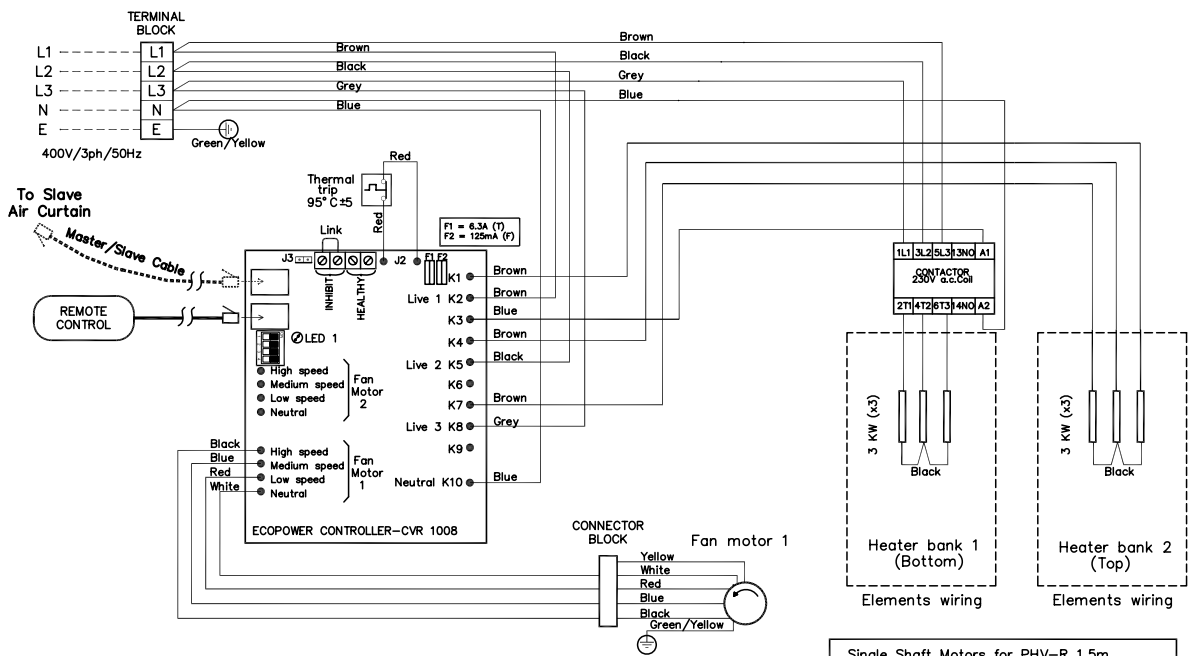

PHV1500ER + ECOPOWER

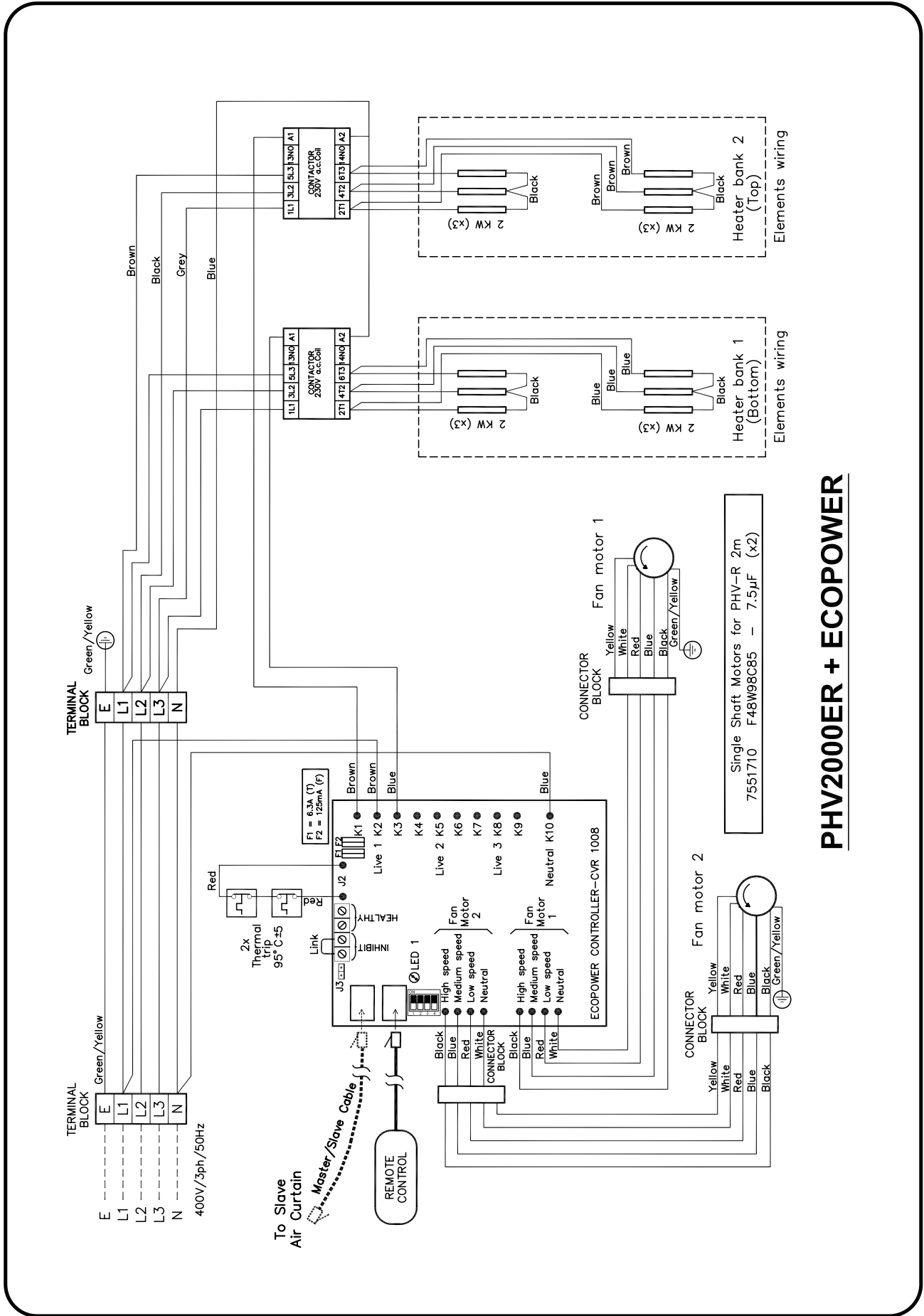

PHV2000ER + ECOPOWER

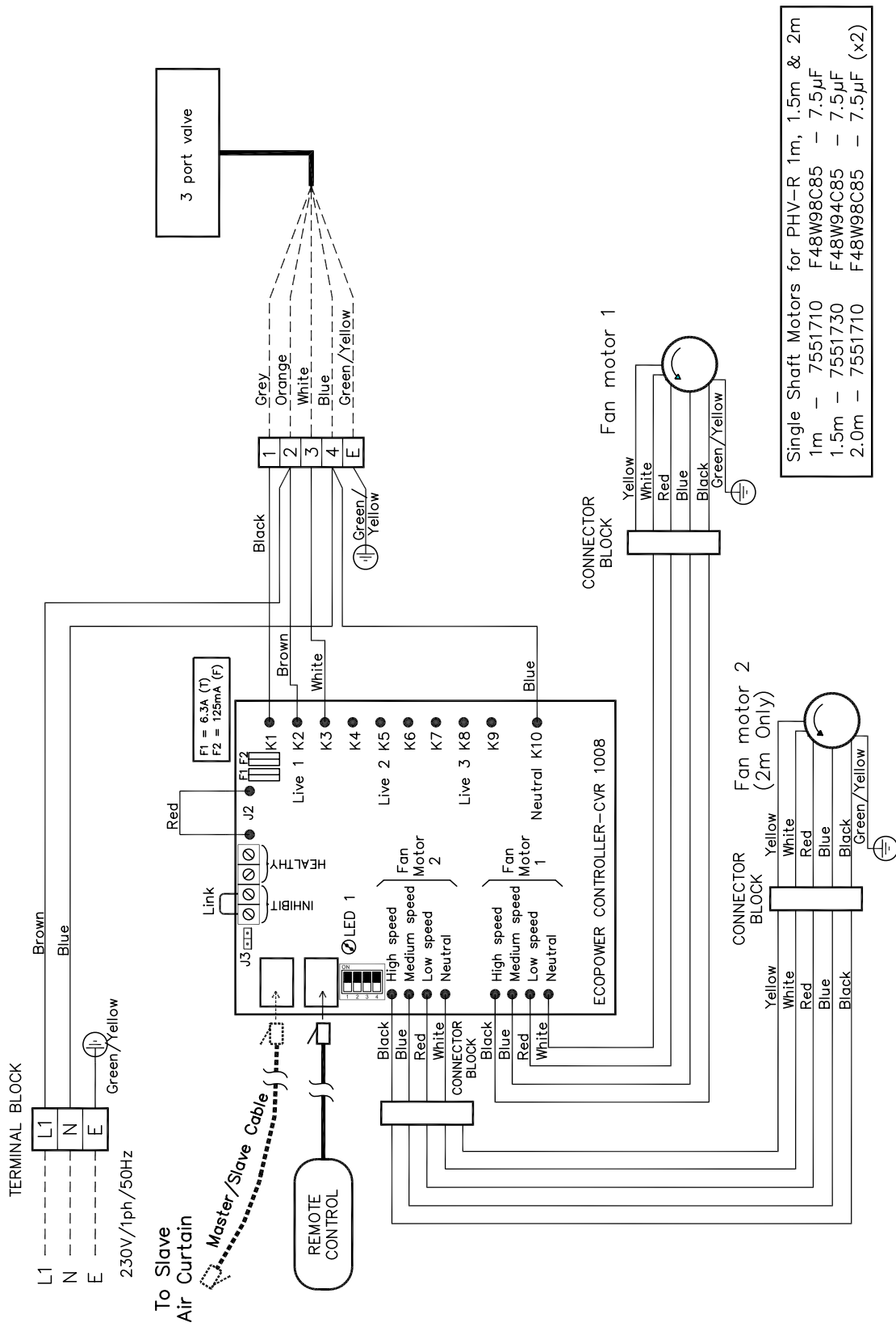

PHV1000WR, PHV1500WR AND PHV2000WR + ECOPOWER

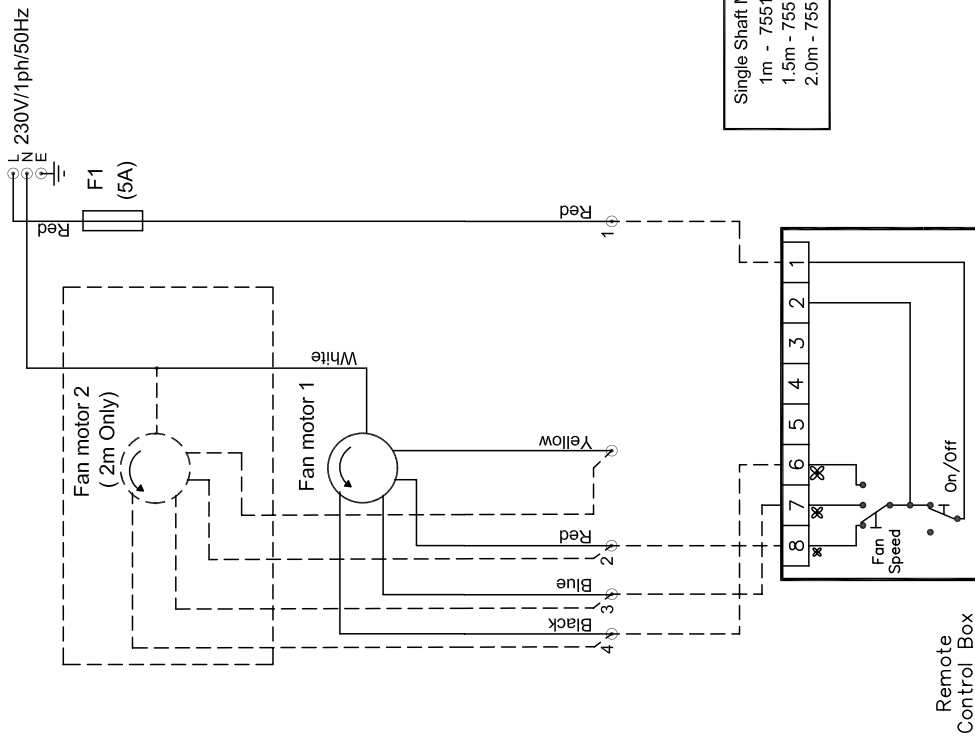

Single Shaft Motors for PHV Range
 1m - 7551710 F48W98C85 - 7.5µF
 1.5m - 7551730 F48W94C85 - 7.5µF
 2.0m - 7551710 F48W98C85 - 7.5µF (x2)

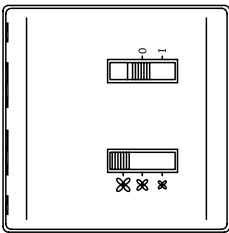

Remote Control Box

PHV1000AR, PHV1500AR AND PHV2000AR

Ecopower Remote Control Operation

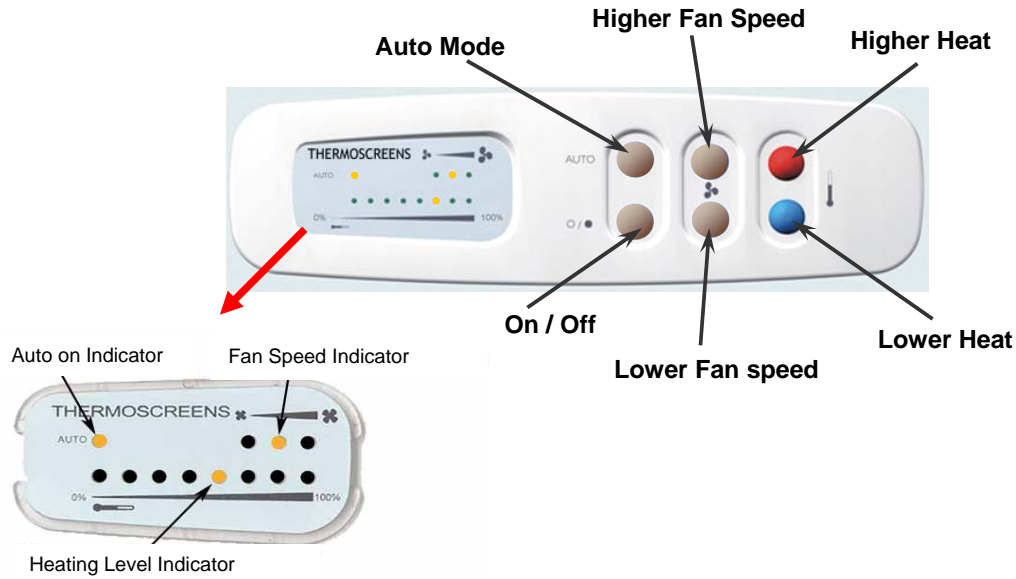

Push On/Off switch to turn On, then operate as follows :-

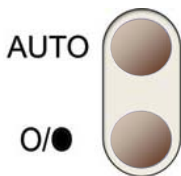

Auto Switches between manual and automatic heat regulation. The Auto on indicator LED is lit for "Auto Mode" and un-lit for "Manual Mode".

On/Off Turns the air curtain On or Off (when turned off the settings for heat and fan speed are retained). If the air curtain is heating when it is turned off with this switch the fan will run-on for a time (approx. 2 minute) to dissipate excess heat.



Selects the appropriate fan speed (Low, Medium or High) to suit the air curtain height and outside wind conditions. Fan speed can be changed when unit is in either Auto or Manual Modes. A fan speed indicator LED shows which fan speed is selected.

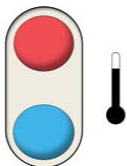

In "Auto Mode" the air curtain measures the incoming air temperature and automatically selects the necessary amount of heat to keep it at the level selected. Heating level indicator LED's go from 0% to 100% in 8 steps to show the level selected.

In "Manual Mode" heat output can be selected as Zero, Half Heat or Full Heat. Heating level indicator LED's go 0%, 50% or 100% to show the level selected.

Push On/Off switch again to turn Off

Note If the mains supply is isolated or cuts-out during operation the On/Off switch will need to be pushed again to start the air curtain when the mains supply is restored. The safety thermal cut-out in the air curtain may operate, if this happens it will need to be reset by a competent technician.

Commissioning

Once the air curtain is functioning check that the fans operate at Low, Medium and High speeds, that there is no excessive mechanical noise coming from the fans and that all fans are working. If the unit is electric heated or water heated check that the air stream from the discharge grille warms up across the whole length of the air curtain when heating is selected. Check that heating increases as higher heat is selected and feel to see that the warm air stream is reaching across the doorway with door open or closed. If an Ecopower controller is being used check its operation in Manual Mode. Then select Auto Mode and increase the heating set point until the air stream warms up. Reduce the heating set point until the air stream goes cold.

Before leaving site it is important that the air curtain installation is “Handed-Over” to the end user or his representative and the operation of it is fully explained and that they understand how it operates. Explain also the service intervals and that the unit must be regularly cleaned and if it has filters fitted that these require regular cleaning/replacement.

Fault Conditions

In the event of a fault the thermal cut out(s) on electric heated units (*Note: If the mains supply is isolated during operation then the thermal cut outs may operate*) or internal fuses may operate. The thermal cut out(s) are located within the unit directly above the element banks (one on the 1 & 1.5m and two on the 2m model). For Ecopower units the internal fuses are located on the PCB. For Ambient units the fuse is located within the control panel at the left hand side of the air curtain.

In the case of a fault condition (refer to flowchart) do not attempt to reset the thermal cut outs or replace the fuses, arrange for a Thermoscreens appointed technician or certified electrician to attend the unit to investigate the reason why the thermal cut outs/fuse(s) have operated. Once the cause has been determined and rectified, they will reset/replace the thermal cut out/fuse and function test the unit.

PCB Status

Fitted on the PCB board inside of the air curtain is an LED shown as LED1 on wiring diagrams that will indicate the Ecopower control status.

1. LED flashing green – operation normal.
2. LED flashing red – low supply voltage.
3. LED permanently red – thermal cut outs open circuit (electrically heated models only).

Note to reset the thermal cut outs please refer to Fault Conditions section detailed above.

User Fault Finding Flowchart (for Ecopower Control)

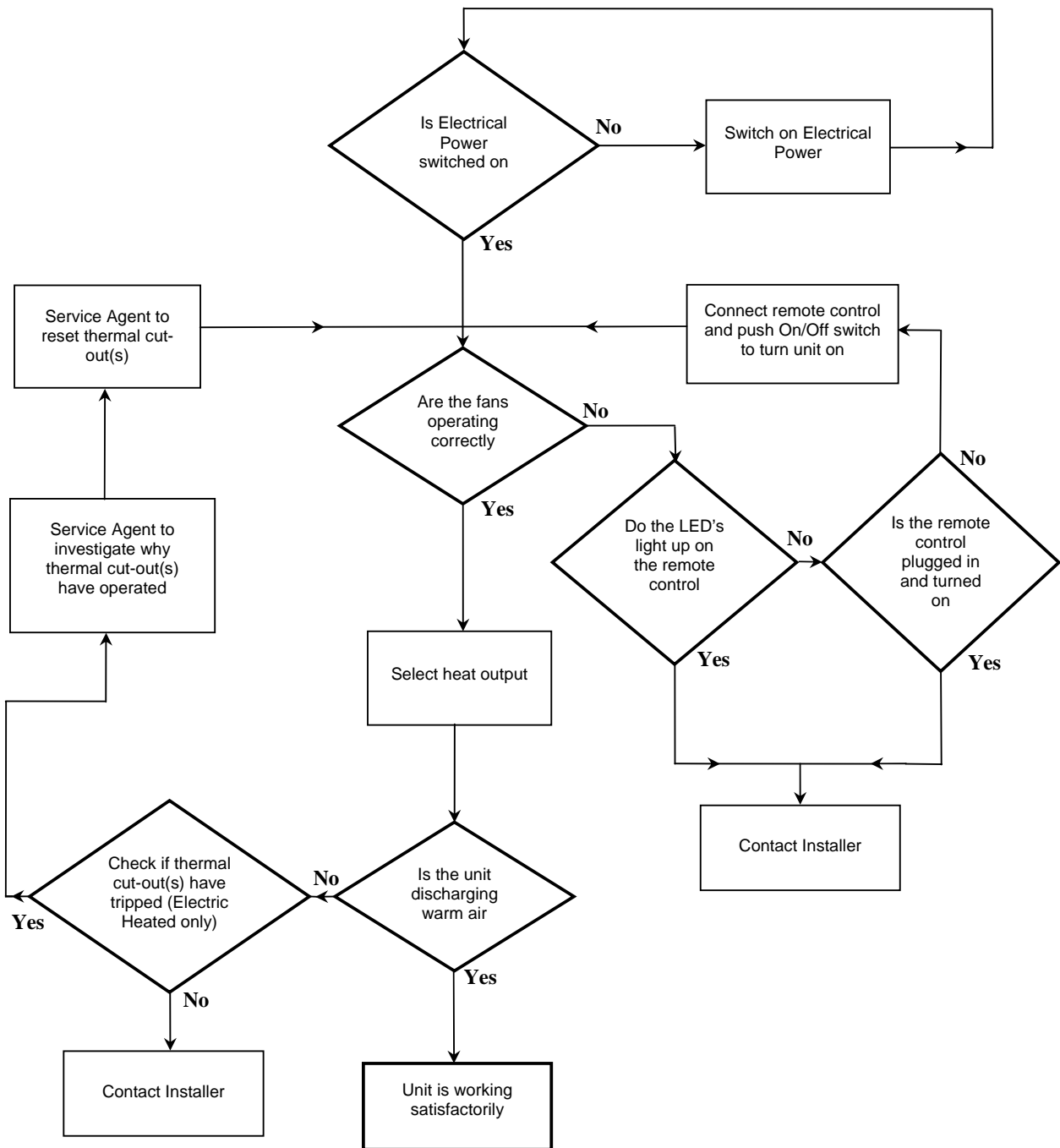

Service & Maintenance

Always disconnect and isolate the mains electricity supply before installing, maintaining or repairing this equipment. Note: All maintenance/repairs should only be carried out by a competent electrician or Thermoscreens appointed technician.

To ensure the air curtain operates at full efficiency the inlet/outlet grilles, fan impellers, housings and motors must be kept free of dust and debris. Build up of dust on the fan impellers can cause vibration, noise and excessive wear on the motor bearings.

Frequency of cleaning will depend on the environment, but we would recommend that the unit be cleaned a minimum of every 3 months (failure to adequately maintain the unit and provide a suitable cleaning schedule will result in performance degradation and reduce the life expectancy of the air-curtain).

Remove the grille core from the air curtain. Vacuum and clean the build-up of dirt and debris within the air-curtain (*please note that the motor(s) are permanently lubricated and require no additional lubrication*). If filters are fitted, ensure these are regularly inspected and cleaned or replaced. All dirty or blocked filters should be immediately replaced.

Once the air curtain has been cleaned check all electrical connections within the unit ensuring terminals are tight and that crimped connections have not become loose. Refit the grille core in the recessed grille. Reconnect the electrical supply and fully function test the air-curtain to ensure correct operation (See Commissioning).

Warranty

If any problems are encountered, please contact your installer/supplier. Failing this please contact the Thermoscreens warranty department. All units are covered by a two year warranty period.

Care has been taken in compiling these instructions to ensure they are correct, although Thermoscreens disclaims all liability for damage resulting from any inaccuracies and/or deficiencies in this documentation. Thermoscreens retain the right to change the specifications stated in these instructions.

Thermoscreens Ltd
St. Mary's Road Nuneaton
Warwickshire England
CV11 5AU

Email: sales@thermoscreens.com

Tel: + 44 (0) 24 7638 4646

Fax: + 44 (0) 24 7638 8578

www.thermoscreens.com