

Installation Method

First Fix

- A Recessed Junction box should be installed to allow hand dryer to sit flush with the wall. Height should be determined from table overleaf

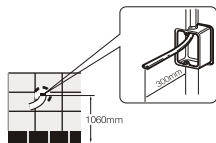

Cover Removal

- Remove the Allen Screws on either side of the hand dryer, lift off cover. Make sure to put the cover in a location where it will not be damaged.

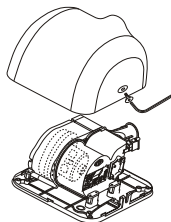

Mounting

- Drill mounting holes according to the area that the Hand Dryer is to be installed in (see Overleaf) & mount the hand dryer.
- Connect the electrical cables and ensure correct Polarity.

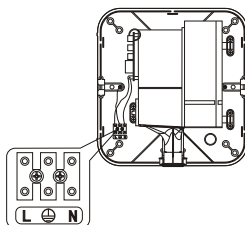

NOTE: The Sensitivity of the Cheetah is fixed. Do not install with anything below the dryer that can start the dryer. E.g. Shelves, Radiators, above sinks etc.

Replace Cover

- Replace the cover
- **NOTE: The cover is earthed through the mounting screws. Please ensure they are firmly attached prior to re-energising the power supply.**
- Install the two Allen Screws and test the hand dryer

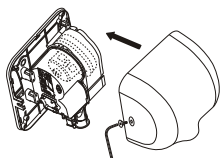

Daily Use & Maintenance

External Maintenance:

- Regularly clean cover with a soft cloth, do not use harsh detergents, Abrasive, Acid or Alkali Based Cleaning products or cleaning brushes as they may damage the cover finish.
- If using a chemically impregnated cloth please test on an inconspicuous area prior to use to check suitability.

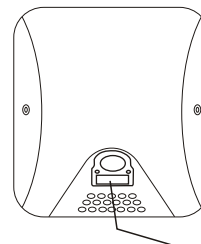

Infra-Red Sensor

Internal Maintenance

- After turning off the power supply, remove cover and check all connections,
- Clean away any dirt that has deposited inside the hand dryer.
- Remove the motor housing and check the brushes on the motor for wear. **Replace worn Brushes.**

Please note: Brushes are a consumable item and are not covered under warranty

Method Of Operation:



Insert the back of your hands



Turn your hands over

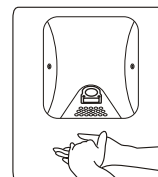

Rub your hands together until dry

Packing List

ATC Cheetah Hand Dryer	User Manual
5mm Plastic wall plug x4	Allen Key
30mm Self Tapping Screws x4	

For Sales and Service enquiries please contact **atc** on the numbers below.

atc
ELECTRICAL &
MECHANICAL
Heating & Ventilation Division

atc House,
Broomhill Drive
Tallaght
Dublin 24
IRELAND

PH 003531 4625111
FX 003531 4520887
Email: sales@atc.ie

www.atc.ie

ATC CHEETAH Hand Dryer

Z-2281 M/W/B

atc

Specification

Voltage	230v ~ 50Hz	Sound Level	75 dB@1m
Phase	1Φ	Sensor Range	15-20cm (fixed)
Load	1475w	IP Class	IPX1
Air Speed	65m/s	Size (mm)	295x320x170
Heat level	900w	Nett Weight	4.5kg

Features

- Infra-Red operated Hygienic High Speed hand dryer
- Solid Stainless Steel or Painted Steel
- Auto stop Function after 45s to prevent overrun

Product Description

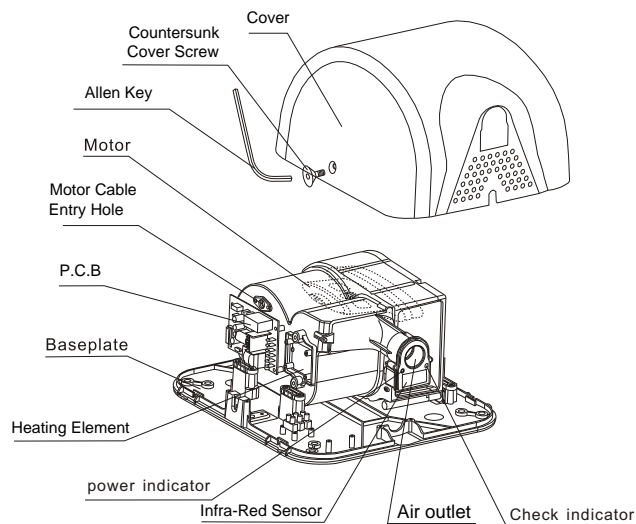

Circuit Diagram

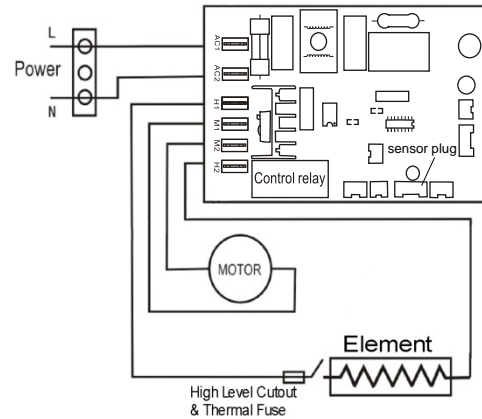

Environmental Protection



Waste electrical products should not be disposed of with household waste, please recycle this product where the facilities exist. Please check with your local authority

Warranty

ATC Electrical & Mechanical provides a 2-year limited parts warranty for the Z-2281 M/W/B as long as the following conditions are followed: Installation and use of the hand dryer is in accordance with the instruction manual, which is packed with hand dryer.

In order to arrange parts for the hand dryer the following information is required.

Receipt number: _____

Date of Manufacture: _____

Date of Purchase: _____

Precautions before installation

Do not install in the following locations; Installation in these areas can cause the unit to malfunction

- Areas with Temperatures below 0°C or above 40°C
- In direct Sunlight or areas above reflective surfaces
- Areas where the unit can come into direct contact with water
- Above counters or sinks
- Areas of High moisture and Humidity levels
- Locations containing Corrosive or Oxidizing gasses
- Areas at Altitude above 2000m

Installation Location

- The Chart below shows the recommended mounting height for the Hand Dryer.
- Make sure the dryer is mounted more than 150mm away from walls on either side of the dryer.
- Ensure the wall the hand dryer is mounted on is flat and smooth.
- Do not mount the unit behind doors where the opening of the door may damage the dryer
- Do not install the dryer with the power connected; the dryer must be connected by a qualified electrician when being installed.

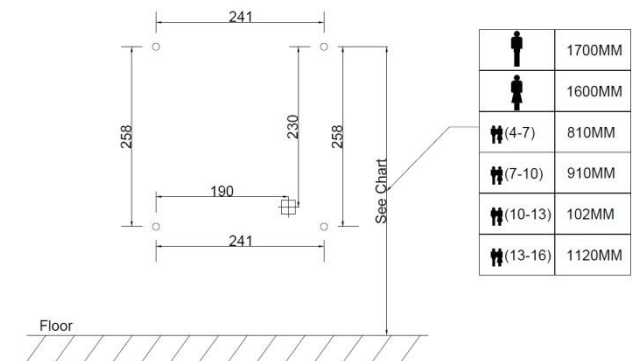

The power cord Supplying the hand dryer should be at least 1.5m² 2 Core & Earth